



**VAYA**

# **E-SCOOTER**

**USER GUIDE**

PO-1581



 **Danish manual can be found at:**  
[www.envivo.nu/dk](http://www.envivo.nu/dk)

## CONTENT

BEFORE YOU START .....	4
WARNINGS AND CAUTION .....	4
BOX CONTENT .....	5
SCOOTER OVERVIEW .....	5
GETTING STARTED.....	6
ASSEMBLY.....	6
FOLDING.....	7
UNFOLDING.....	7
DISPLAY .....	8
OPERATING PRINCIPLES .....	8
OPERATION.....	8
HOW TO RIDE YOUR E-SCOOTER.....	8
PLEASE READ THE FOLLOWING INSTRUCTIONS CAREFULLY.....	8
WEIGHT AND SPEED LIMITATIONS .....	8
WEIGHT RESTRICTIONS.....	8
SPEED LIMITS .....	9
OPERATING RANGE .....	9
BATTERY INFORMATION AND SPECIFICATIONS.....	9
BATTERY POWER .....	9
BATTERY SPECIFICATIONS.....	9
CHARGER SPECIFICATIONS.....	9
CHARGING YOUR E-SCOOTER.....	10
INSPECTION, MAINTENANCE AND STORAGE .....	10
INSPECTING YOUR E-SCOOTER .....	10
CLEANING YOUR E-SCOOTER .....	10
REAR LIGHT .....	11
SCOOTER SPECIFICATIONS.....	11
SYMBOL EXPLANATION .....	11

## BEFORE YOU START

Before you use the E-Scooter for the first time, please read the USER MANUAL thoroughly and follow the instructions and warnings to ensure your own safety and the safety of others.

It is recommended to keep the instruction manual for future reference.

For further information visit [www.envivo.nu](http://www.envivo.nu)

**WARNING:** Failure to follow the basic instructions and safety precautions listed in the USER MANUAL, can lead to damage to your E-Scooter, other property damage, serious bodily injury, and even death.

## WARNINGS AND CAUTION

1. Recommended age use 14+ years.
2. The battery charger may be used by children aged from 8 years and above and persons with reduced physical, sensory or mental capabilities or lack of experience and knowledge if they have been given supervision or instruction concerning use of the appliance in a safe way and understand the hazards involved.
3. Children should be supervised to ensure that they do not play with the appliance. Cleaning and user maintenance shall not be done by children.
4. If the charger supply cord is damaged, it must be scrapped, and the charger replaced by the manufacturer or its service agent – please contact the service line.
5. Do not attempt to modify, change or replace your battery or any other part of the unit.
6. Users who disassemble the E-Scooter will forfeit their right of warranty.
7. Only use the charger included in the box. The E-Scooter must only be supplied at safety extra low voltage corresponding to the marking on the E-Scooter.
8. The included charger is only to be used with this E-scooter and not with any other electrical equipment. Do not use the charger to charge any non-rechargeable batteries.
9. Please wear all appropriate safety and protective gear while operating the E-Scooter. See the operating principles section for more information.
10. Make sure to wear comfortable clothes and flat closed-toe shoes when operating your E-Scooter.
11. Do not use the E-Scooter to place yourself or anyone else and their property in danger.
12. Do not operate the E-Scooter while under the influence of drugs and/or alcohol.
13. Use your best judgment to keep yourself out of dangerous situations with your E-Scooter.
14. Do not attempt any stunts or tricks with your E-Scooter.
15. Do not turn sharply, especially at high speeds.
16. Do not abuse your E-Scooter, doing so can damage your unit and cause failure to the operating system which can lead to injury.
17. Do not drive in or near puddles of water, mud, sand, stones, gravel, debris or near rough and rugged terrain.
18. The E-Scooter can be used on paved surfaces that are flat, clean, dry and where possible, away from other users. If you encounter uneven pavement, please lift your E-Scooter over and past the obstruction.
19. Do not ride in darkness.
20. Rear brake will be hot after use: do not touch after braking.
21. If the handlebar grips become damaged and expose the metal ends of the handlebar, these must be capped using internally fitted “bar end plugs”.
22. Do not ride in inclement weather. snow, rain, hail, sleet, on icy surfaces or in extreme heat
23. For operating the E-Scooter through bumps and uneven pavement- Bend your knees when riding on bumpy or uneven pavement to absorb the shock and vibration and help you to keep your balance. If you are unsure if you can safely ride on a specific terrain, step off and carry your E-Scooter. ALWAYS BE ON THE SIDE OF CAUTION.
24. Do not attempt to ride over bumps or objects greater than 1.5 cm even when prepared and bending your knees.
25. **PAY ATTENTION** - look at where you are riding and be aware of the surfaces conditions, people, places, property and objects around you.
26. Do not operate the E-Scooter in crowded areas.
27. Operate your E-Scooter with extreme consideration for people and property at all times.
28. Do not operate the E-Scooter while talking, texting, or looking at your phone.
29. Do not ride your E-Scooter where it is not permitted.
30. Not intended for use on public roads in some countries: check the limitations of use according to national regulations of road safety.

31. Do not climb or travel down steep hills with your E-Scooter.
32. The E-Scooter is intended for use by a single individual, DO NOT attempt to operate the E-Scooter with two or more people.
33. Do not carry anything while riding the E-Scooter.
34. At higher speeds, always take into consideration longer stopping distances.
35. Do not attempt to jump on or off your E-Scooter while driving.
36. Do not operate your E-Scooter off-road.
37. Do not exceed the maximum weight limit (100 kg).

**WARNING:** The warranty does not cover improper use of the product or the failure of users to follow the warnings and operation instructions in this user guide.

## BOX CONTENT



**E-Scooter**

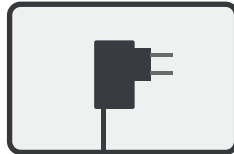

**Charger**

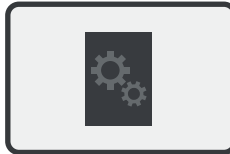

**Manual**



**Tool bag with  
hex key and screws**

## SCOOTER OVERVIEW

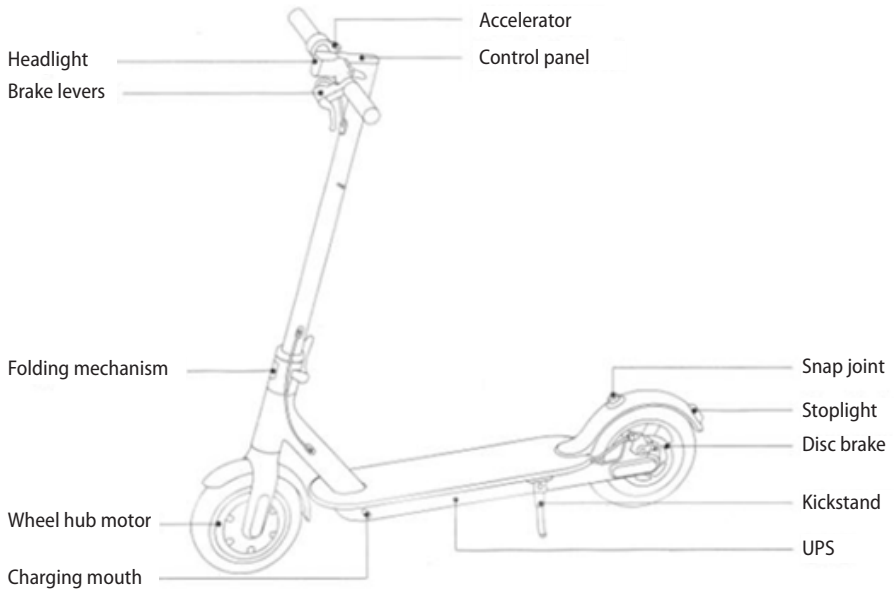

## GETTING STARTED

### ASSEMBLY

Fixate E-Scooter hole and open kick stand.



Assemble the handle bar.



Tighten the screw using the included hex-key.



Test the E-Scooter after assembly.



**WARNING:** Before using the E-Scooter make sure that the handle bar is securely assembled.

## FOLDING

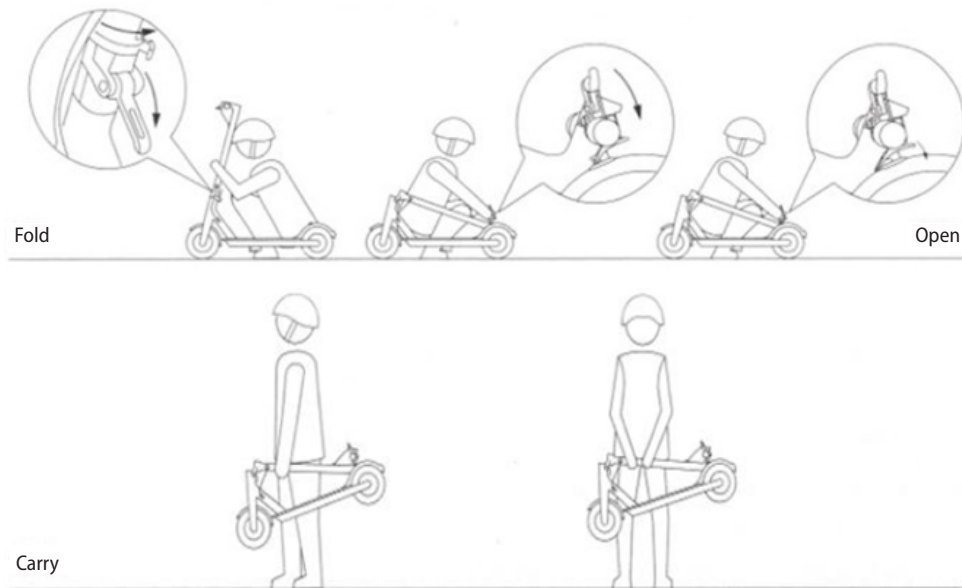

Release the locking mechanism on the front bar.

Gently click the front bar into the snap joint on the rear fender.

## UNFOLDING

Press down the rear fender and pull up the front bar.

Rise the front bar and secure the locking mechanism.

**WARNING:** Before riding the E-Scooter always check that the locking mechanism is fully locked.

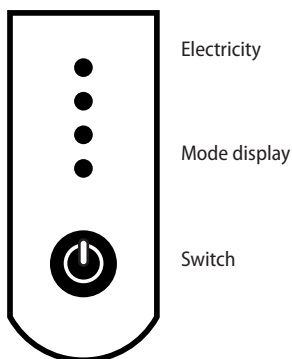
**DISPLAY****OPERATING PRINCIPLES****OPERATION**

- Hold the Switch button for 2 seconds to turn the E-Scooter OFF or ON.
- Short press the Switch button to turn on front light.
- Double short press the Switch button to toggle between power saving mode and normal mode.

In power saving mode the max speed of the E-Scooter is 18 km/h.

When in power saving mode the bottom two lights are green. When in normal mode the bottom two lights are white.

**HOW TO RIDE YOUR E-SCOOTER**

- Switch on the E-Scooter.
- Stand with one foot on the footboard.
- To start you must manually start riding before the E-Scooter will accelerate. Use one foot to push the E-Scooter forward and press down the accelerator lever.
- The accelerator lever is located on the right handlebar, press the lever down to accelerate and release to decelerate.
- The hand operated front brake is located on the left handle bar, press the lever down progressively to decelerate.

**NOTE:** You need to manually push the E-Scooter forward before you can start accelerating.

**PLEASE READ THE FOLLOWING INSTRUCTIONS CAREFULLY**

**Step 1:** Getting started – Take your E-Scooter out of the box and place it flat on the floor.

**Step 2:** Charging your E-Scooter – Make sure the E-Scooter is fully charged before your initial use. For charging instructions, please follow details under the battery and charging specifications.

**Step 3:** Wear all proper safety gear, including but not limited to a helmet, knee pads, elbow pads and wrist guards.

**WEIGHT AND SPEED LIMITATIONS**

**WARNING:** Speed and weight limits are set for your own safety. Please do not exceed the limits listed in the user manual.

**WEIGHT RESTRICTIONS**

Maximum weight: 100 kg



## SPEED LIMITS

Maximum speed in standard operating mode: 22 kmh.

## OPERATING RANGE

Please notice the E-Scooter can travel 20km on a fully charged battery in ideal conditions. The following are some of the major factors that will affect the operating range of the E-Scooter.

**Terrain:** A smooth flat surface will increase your driving distance, whereas driving uphill or on rough or uneven terrain will reduce your distance significantly.

**Weight:** The weight of the user can affect the driving distance; a lighter user will have a farther range than a heavier user.

**Ambient temperature:** Please ride and store the E-Scooter under the recommended temperature, which will increase driving distance, battery life and overall performance of your E-Scooter.

**Maintenance:** Correct battery charging and maintenance will prolong the battery life.

**Speed and Driving Style:** Maintaining a moderate speed will increase your distance; while traveling at high speeds for extended periods, frequent starts, stops, idling, along with frequent acceleration and deceleration will reduce your overall distance.

## BATTERY INFORMATION AND SPECIFICATIONS

This section is intended to provide you with basic information about your battery and charger. Please read this section carefully to ensure your safety. For user safety and to prolong the life of your battery, as well as improve battery performance, please follow these instructions.

### BATTERY POWER

When the Battery indicator shows low battery capacity, please charge your battery for 3 hours using the charger that you received in your E-Scooter package. To fully recharge your battery please follow the instructions under "Charging your E-Scooter".

### BATTERY SPECIFICATIONS

Battery: 30\*18650 Lithium-ion battery pack

Charging time: 3 hours

Voltage: 36V

Battery cells: 30 cells

Initial Capacity 6.6Ah

Working Temperature: -10° ~ 40°

Storage Time: 12 months

### CHARGER SPECIFICATIONS

Input: 90-240V, 8A, 50-60Hz

## CHARGING YOUR E-SCOOTER

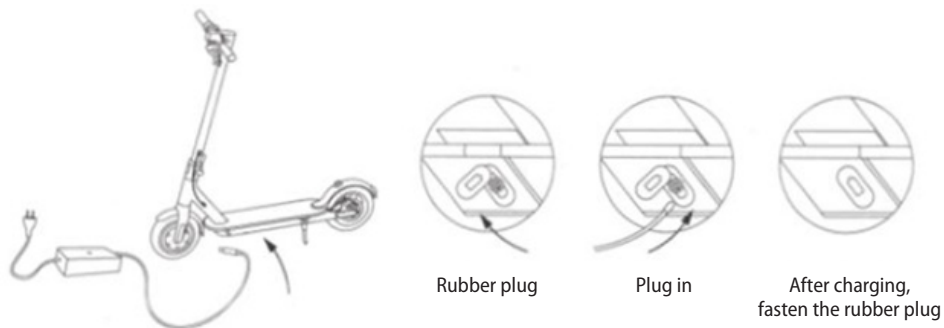

**Step 1:** Ensure that the charging port is clean and dry.

**Step 2:** Plug the charger into the power outlet, then connect the cable with the power supply (90 ~ 240V; 50,60 Hz), make sure the light on the charger is lit GREEN.

**Step 3:** Connect the charging cable into the charging port of the E-Scooter. The indicator light on the charger should change to RED, indicating that your E-Scooter is now being charged. When the red indicator light on the charger turns to GREEN, your E-Scooter is fully charged. A full charge typically occurs within 3 hours. The charger will automatically stop charging when the light is GREEN.

**Step 4:** Please unplug the charger from the E-Scooter and from the power outlet.

**NOTE:** If the GREEN light on the charger does not turn RED when you plug it into your E-Scooter, check that all the connections are properly connected or that the E-Scooter is not already fully charged.

## INSPECTION, MAINTENANCE AND STORAGE

Your E-Scooter requires routine inspection and maintenance. This chapter describes maintenance steps and important operating tips. Before you perform the following operations, ensure the power and charging cable is disconnected.

### INSPECTING YOUR E-SCOOTER

Before you ride the E-Scooter; check that the front wheel is properly aligned and connected to the handlebars. Position the front wheel between your feet and gently move the handle bar from side to side to check wheels follows the handle bars. If any problems, contact after sales support.

Routinely check the body of the E-Scooter and tyres for damage or excessive wear, check all bolts and screws and tighten them if needed.

### CLEANING YOUR E-SCOOTER

Disconnect the charger and turn off your E-Scooter.

Avoid using water or other liquids and cleaners on the E-Scooter while cleaning. Wet a clean cloth with clean soapy water, wring out the cloth thoroughly, and wipe the body of the E-Scooter, making sure that water does not get into the power button, charging port, the foot mats, locking mechanism or tyres.

### STORING YOUR E-SCOOTER

Fully charge your battery before storing.

If you are storing your E-Scooter for an extended period of time, please fully charge your E-Scooter at least once every three months.

If the ambient temperature of the storage location is below 0°, please do not charge. You must bring the E-Scooter into a warmer environment before charging. Check under Battery Information and Specifications for more details.

To prevent dust from getting into your E-Scooter, try wrapping it or sealing it with its original packaging.

Store your E-Scooter indoors, in a dry and suitable temperature.

## SCOOTER SPECIFICATIONS

Net weight: 11 kg

Load: 100 kg

Max. speed limit: 22 kmh

Range: up to max 20km in one battery charge

Max. Climbing Limit: 15°

## SYMBOL EXPLANATION



For indoor use only.



This tool is double Insulated.



Wear personal protective equipment.



Read manual before operating the product.



Class III protection against electric shock.

